UNIT 17 INVENTORY MANAGEMENT

Objectives

Upon completion of this unit, you should be able to:

- understand the meaning of inventory and identify inventory related cost parameters
- learn about various types of inventory policies
- appreciate the role of selective inventory management
- know the exchange curve concept for aggregate inventory planning
- get a feel of some mathematical models of inventory analysis
- perform sensitivity analysis on a type of model
- compute safety stocks
- understand the problems of slow moving items
- appreciate the role of computers in inventory control
- have a brief idea about recent developments in inventory management.

Structures

- 17.1 Introduction to Inventory Systems
- 17.2 Functions of Inventory
- 17.3 Classification of Inventory Systems
- 17.4 Selective Inventory Management
- 17.5 Exchange Curve and Aggregate Inventory Planning
- 17.6 Deterministic Inventory Models
- 17.7 Probabilistic Inventory Models
- 17.8 Inventory Control of Slow Moving Items
- 17.9 Recent Developments in Inventory Management
- 17.10 Concluding Remarks
- 17.11 Summary
- 17.12 Key Words
- 17.13 Self-assessment Exercises
- 17.14 Further Readings

17.1 INTRODUCTION TO INVENTORY SYSTEMS

Concept of Inventory .

Inventory' may be defined as usable but idle resource'. If resource is some physical and tangible object such as materials, then it is generally termed as stock. Thus stock or inventory are synonymous terms though inventory has wider implications.

Broadly speaking, the problem of inventory management is one of maintaining, for a given financial investment, an adequate supply of something to meet an expected demand pattern. This could be raw materials work in progress finished products or the spares and other indirect materials.

Inventory can be one of the indicators of the management effectiveness on the materials management front. Inventory turnover ratio (annual demand/average inventory) is an index of business performance. A soundly managed organisation will have higher inventory turnover ratio and vice-versa.

Inventory management deals with the determination of optimal policies and procedures for procurement of commodities. Since it is quite difficult to imagine a real work situation in which the required material will be made available at the point of use instantaneously, hence maintaining, inventories becomes almost necessary. Thus inventories could be visualised as 'necessary evil'.



Inventory Related Cost

An inventory system may be defined as one in which the following costs are significant:

- a) cost of carrying inventories (holding cost)
- b) cost of incurring shortages (stockout cost)
- c) cost of replenishing inventories (ordering cost)

a) Cost of carrying inventory : This is expressed in Rs./item held in stock/unit time. This is the opportunity cost of blocking material in the non-productive form as inventories. Some of the cost elements that comprise carrying cost are-cost of blocking, capital (interest rate); cost of insurances; storage cost; cost due to obsolescence, pilferage, deterioration etc. It is generally expressed as a fraction of value of the goods stocked per year. For example, if the fraction of carrying charge is 20% per year and a material worth Rs. 1,000 is kept in inventory for one year, the unit carrying cost will be Rs. 200/item/year. It is obvious that for items that are perishable in nature, the attributed carrying cost will be higher.

b) Cost of incurring shortages: It is the opportunity cost of not having an item in stock when one is demanded. It may be due to lost sales or backlogging. In the backlogging (or back ordering) case the order is not lost but is backlogged, to be cleared as soon as the item is available on stock. In lost sales case the order is lost. In both cases there are tangible and intangible costs of not meeting the demand on time. It may include lost demand; penalty cost; emergency replenishment; loss of good-will etc. This is generally expressed as Rs./item short/unit time.

c) Cost of replenishing inventory: This is the amount of money and efforts expended in procurement or acquisition of stock. It is generally called ordering cost. This cost is usually assumed to be independent of the quantity ordered, because the fixed cost component is generally more significant than the variable component. Thus it is expressed as Rs. /order.

These three types of costs are the most commonly incorporated in inventory analysis, though there may be other costs parameters relevant in such an analysis such as inflation, price discounts etc.

Importance of Inventory Management

Scientific inventory management is an extremely important problem area in the materials management function. Materials account for more than half the total cost of any business and organisations maintain huge amount of stocks much of this could be reduced by following scientific principles. Inventory management is highly amenable to control. In the Indian industries there is a substantial potential for cost reduction due to inventory control. Inventory being a symptom of poor performance we could reduce inventories by proper design of procurement policies by reduction in the uncertainty of lead times by variety reduction and in many other ways.

17.2 FUNCTIONS OF INVENTORY

As mentioned earlier, inventory is a necessary evil. Necessary, because it aims at absorbing the uncertainties of demand and supply by 'decoupling' the demand and supply sub-systems. Thus an organisation maybe carrying inventory for the following reasons:

- a) Demand and lead time uncertainties necessitate building of safety stock (buffer stocks) so as to enable various sub-systems to operate somewhat in a decoupled manner. It is obvious that the larger the uncertainty of demand and supply; the larger will have to be the amount of buffer stock to be carried for a prescribed service level.
- b) Time lag in deliveries also vecessitates building of inventories. If the replenishment lead times are positive then stocks are needed for system operation.
- c) Cycle stocks may be maintained to get the economics of scale so that total system cost due to ordering, carrying inventory and backlogging are minimised. Technological requirements of batch processing also build up cycle stocks.
- d) Stocks may build up as pipeline inventory or work-in-process inventory due to finiteness of production and transportation rates. This includes materials actually

being worked on or moving between work centres or being in transit to distribution centres and customers.

- e) When the demand is seasonal, it may become economical to build inventory during periods of low demand to ease the strain of peak period demand.
- f) Inventory may also be built up for other reasons such as: quantity discounts being offered by suppliers, discount sales, anticipated increase in material price, possibility of future non-availability etc.

Different functional managers of an organisation may view the inventory from different viewpoints leading to conflicting objectives. This calls for an integrated systems approach to planning of inventories so that these conflicting objectives can be scrutinised to enable the system to operate at minimum total inventory related costs-both explicit such as purchase price, as well as implicit such as carrying, shortage, transportation and inspection costs. Concepts and techniques useful in analysis these problems to arrive at sound policy decisions are the focal point of presentation in this unit.

17.3 CLASSIFICATION OF INVENTORY SYSTEMS

Lot Size Reorder Point Policy

Under this operating policy the inventory status is continuously reviewed and as soon as the inventory level falls to a prescribed value called 'Reorder Point'. A fresh replenishment order of fixed quantity called Economic Order Quantity (EOQ) is initiated. Thus the order size is constant and is economically determined. This is one of the very classical type of inventory policies and a lot of mathematical analysis has appeared on this type of policy. Figure I shows the typical stock balance under this type of inventory policy. The solid line in this figure represents the actual inventory held in practical situation with a finite lead time, the lead time being defined as the time delay between the placing of a replenishment order and its subsequent receipt. The broken line indicates the inventory that would be held in the ideal situation if no lead time existed. Lot size and reorder point are the two decision variables involved in the design of the policy.

Figure I: Typical Inventory Balances for EOQ—Reorder Point Policy.

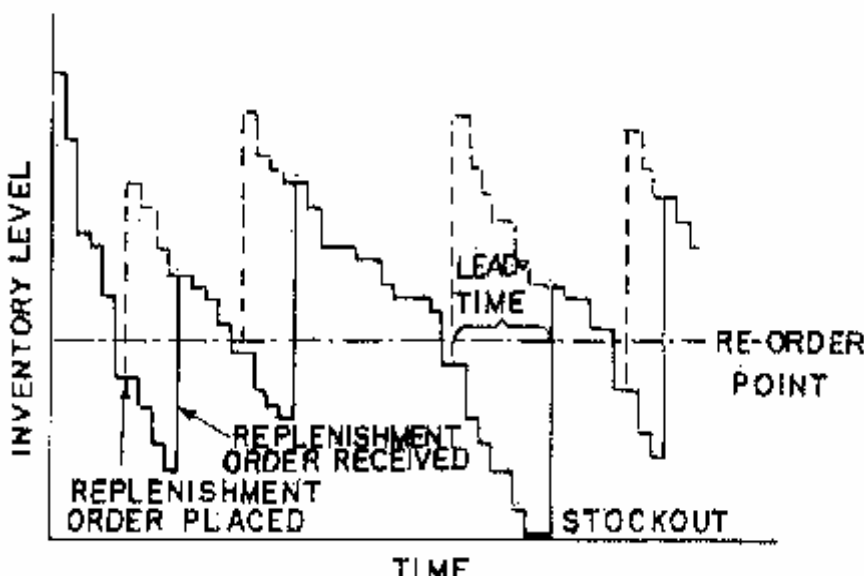

Fixed Order Interval Scheduling Policy

Under this policy the time between the consecutive replenishment orders is constant. There is a maximum stock level(s) prescribed and the inventory status is reviewed periodically with a fixed interval (T). At each review an order of size Q is placed which takes the stock on hand plus an order equal to the maximum stock level. Thus order quantity could vary from period to period. This policy ensures that when the



level of stock on hand is high at review, a smaller size replenishment order is placed. Figure II shows the typical stock balances under this fixed reorder cycle policy. S , the maximum stock level and T the review period are the decision variables under this policy.

Figure II: Fixed Reorder Cycle Policy.

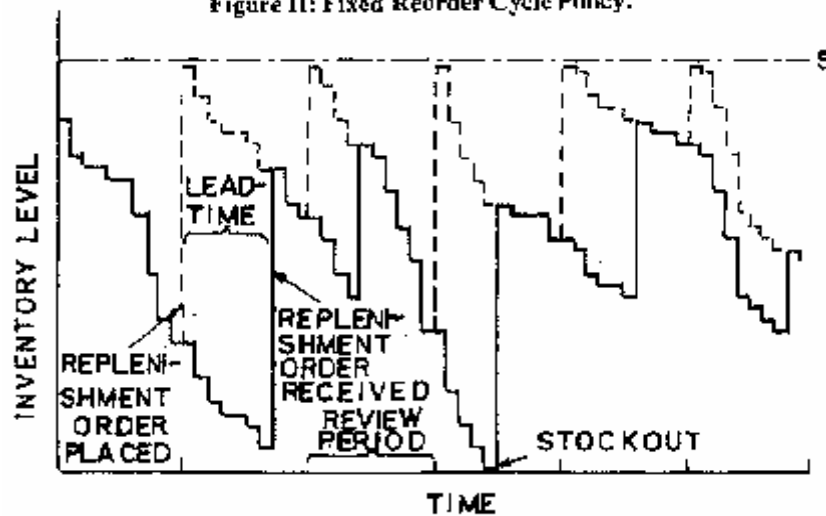

Optional Replenishment Policy

This is very popularly known as the (s, S) policy. Figure III shows the typical stock balance under this policy. The status of stock is periodically reviewed and maximum stock level (S) and minimum stock level (s) are prescribed.

Figure III: Typical Inventory Balances in (s, S) Policy.

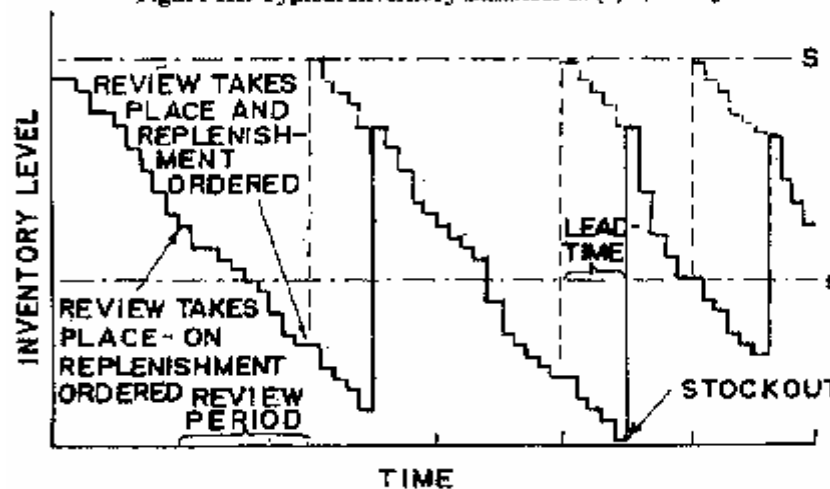

If at the time of review, the stock on hand, is less than or equal to s , an order of size Q is placed so that stock on hand plus on order equals the maximum stock level S . If stock on hand at review is higher than s , no order is placed and the situation is reviewed at the time of next review period. S , s and T (review period) are the decision variables in the design of such inventory policy.

Other Types of Inventory Systems

There may be other policies which may be special cases of the policies mentioned above or may be a combination of these policies. As a special case of (s, S) policy we may have $(S-1, S)$ policy or one-for-one order policy when the maximum stock level may be upto S and whenever there is demand for one unit, a replenishment of one unit is ordered. Such a policy may be quite useful for slow moving expensive items. We may use a combination of lot-size reorder point policy and fixed interval order scheduling policy. Yet another variation of inventory policy could be multiple reorder point policy where more than one reorder point may be established. Other types of inventory systems may be static inventory systems when a single purchase decision is to be made which should be adequate during the entire project duration. Such decisions are not repetitive in nature. Other initial provisioning decisions may be with respect to repairable assemblies such as engines, gearboxes etc. in a bus which may have to be overhauled and for which we have to find adequate number of spare engines to be provided initially.

The right choice of an inventory policy depends upon the nature of the problem; usage value of an item and other situational parameters. We must first select an operating policy before determining optimal values of its parameters.

17.4 SELECTIVE INVENTORY MANAGEMENT

Role of Selective Inventory Control

One of the major operating difficulty in the scientific inventory control is an extremely large variety of items stocked by various organisations. These may vary from 10,000 to 100,000 different types of stocked items and it is neither feasible nor desirable to apply rigorous scientific principles of inventory control in all these items. Such an indiscriminate approach may make cost of inventory control more than its benefits and therefore may prove to be counter-productive. Therefore, inventory control has to be exercised selectively. Depending upon the value, criticality and usage frequency of an item we may have to decide on an appropriate type of inventory policy. The selective inventory management thus plays a crucial role so that we can put our limited control efforts more judiciously to the more significant group of items. In selective management we group items in few discrete categories depending upon value; criticality and usage frequency. Such analyses are popularly known as ABC, VED and FSN Analysis respectively. This type of grouping may well form the starting point in introducing scientific inventory management in an organisation.

ABC Analysis

This is based on a very universal Pareto's Law that in any large number we have 'significant few' and 'insignificant many'. For example, only 20% of the items may be accounting for the 80% of the total material cost annually. These are the significant few which require utmost attention.

Figure IV: ABC Analysis

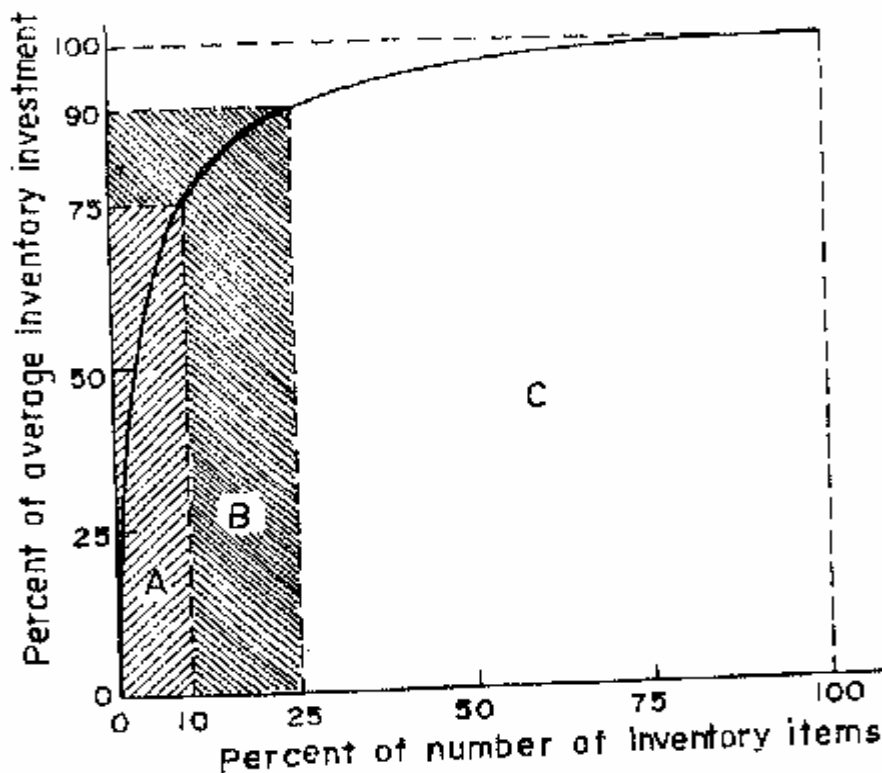

Figure IV shows a typical ABC analysis showing percentage of number of inventory items and percentage of average inventory investment (annual usage value). Annual usage value is the demand multiplied by unit price thus giving monetary worth of annual consumption. It can be seen from this figure that 10% items are claiming 75% of the annual usage value and thus constitute the 'significant few'. These are called A-class items. Another 15% items account for another 15% annual usage value and are called B-class items. A vast majority of 75% items account for only 10% expenditure on material consumption and constitute 'insignificant many' and are

called C-class items. To prepare an ABC type curve we may follow the following simple procedure:

- i) Arrange items in the descending order of the annual usage value. Annual usage value = Annual demand x Unit price.
- ii) Identify cut off points on the curve when there is a perceptible sudden change of slope or alternatively find cut off points at top 10% next 20% or so but do not interpret these too literally- rather as a general indicator.

A very simple empirical way to classify items may be adopted as follows:

$$\text{Average annual usage value } X = \frac{\text{Total material cost per year}}{\text{Total number of items}}$$

A-Class items $\leq 6X$

C-Class items $\geq 0.5X$

In between we have B-class items.

Once the items are grouped into A, B and C category, we can adopt different degree of seriousness in our inventory control efforts. A class items require almost continuous and rigorous control. Whereas B-class items may have relaxed control and C-class items may be procured using simple rules of thumb, as usual.

VED Analysis

This analysis attempts to classify items into three categories depending upon the consequences of material stockout when demanded. As stated earlier, the cost of shortage may vary depending upon the seriousness of such a situation. Accordingly the items are classified into V(Vital), E(Essential) and D(Desirable) categories. Vital items are the most critical having extremely high opportunity cost of shortage and must be available in stock when demanded. Essential items are quite critical with substantial cost associated with shortage and should be available in stock by and large. Desirable group of items do not have very serious consequences if not available when demanded but can be stocked items.

Obviously the % risk of shortage with the 'vital' group of items has to be quite small- thus calling for a high level of service. With 'Essential' category we can take a relatively higher risk of shortage and for 'Desirable' category even higher. Since even a C-class item may be vital or an A-class item may be 'Desirable' we should carry out a two-way classification of items grouping them in 9 distinct groups as A-V, A-E, A-D, B-V, B-E, B-D, C-V, C-E and C.D. Then we are able to argue on the aimed at service-level for each of these nine categories and plan for inventories accordingly.

FSN Analysis

Not all items are required with the same frequency. Some materials are quite regularly required, yet some others are required very occasionally and some materials may have become obsolete and might not have been demanded for years together. FSN analysis groups them into three categories as Fast-moving, Slow-moving and Non-moving (dead stock) respectively. Inventory policies and models for the three categories have to be different. Most inventory models in literature are valid for the fast-moving items exhibiting a regular movement (consumption) pattern. Many spare parts come under the slow moving category which have to be managed on a different basis. For non-moving dead stock, we have to determine optimal stock disposal rules rather than inventory provisioning rules. Categorisation of materials into these three types on value, criticality and usage enables us to adopt the right type of inventory policy to suit a particular situation. In this unit, we shall mainly be developing some decision models more appropriate for A-class and fast-moving items. Later on a brief discussion on the inventory management of slow-moving items will be given.

Activity A

- i) Collect consumption data for 100 different items for an organisation and classify these into an ABC framework following the procedure described.
- ii) List these items in a two-way classification ABC and VED and identify the number of items belonging to each of these 9 distinct group.

.....

.....

.....

.....

.....



17.5 EXCHANGE CURVE AND AGGREGATE INVENTORY PLANNING

Concept of Exchange curve

Exchange curve (or optimal policy curve) is an effective technique to look at the inventories at an aggregate level in the organisation. It is a plot between the total number of orders (TO) per year and the total investment in inventories (TI) per year. The rationale is that for an optimal inventory policy the trade-off between total inventory and total procurement effort as indicated by the total number of replenishment orders per year must be made such that if total number of order are prescribed, we minimise total investment in inventories. Alternatively, if the total investment in inventories (TI) is prescribed then a rational inventory policy must aim at minimising (TO). Optimal inventory policy must exchange (TI) for (TO) in such a manner that

$$(TI) \cdot (TO) = K = \text{constant}$$

Value of constant K is given by

$$K = \frac{1}{2} \left[\sum_{i=1}^N \sqrt{D_i V_i} \right]^2$$

where D_i = Annual requirement of i th item,

V_i = Unit price for i th item, $i = 1 \dots N$

Thus a plot between (TI) and (TO) is a rectangular hyperbola and is called as 'Exchange curve' or 'optimal policy' curve, Figure V shows a typical exchange curve for a situation where the ordering cost is not explicitly known. It shows that any point on the exchange curve is an optimal trade-off between investment in inventories and total number of orders.

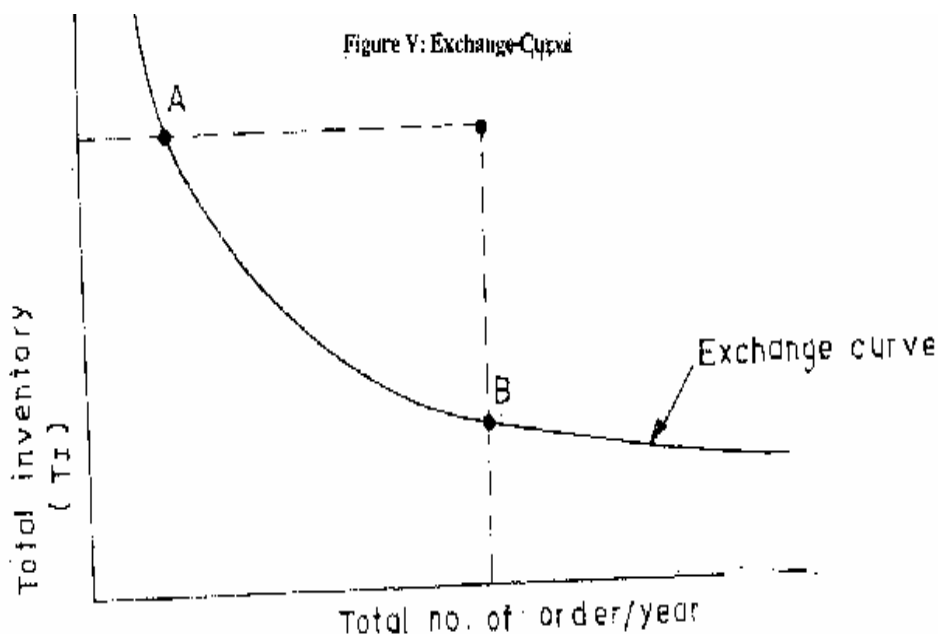



Uses of Exchange Curve

Exchange curve is an effective instrument for aggregate inventory analysis to quickly determine the rationality (or otherwise) of our existing stock provisioning policies. We first plot the exchange curve by computing the value of K for a chosen group of items. Then we determine the total number of orders (TO) and total investment in inventories (TI) under current practice.

If the current practice is at point C (in Figure V) above the exchange curve then it shows that our present procurement policies are not rational. If we want to rationalise these then there are two possible paths-AC or BC; so that we reduce inventory to B for the same ordering effort or reduce number of orders to A for the same inventory. Thus an exchange curve is a useful device at macro-level.

17.6 DETERMINISTIC INVENTORY MODELS

Classical EOQ Model

In this section we discuss some elementary inventory models with deterministic demand and lead time situations. The purpose is to provide an illustration of the mathematical analysis of inventory systems. The most classical of the inventory models was first proposed by Harris in 1915 and further developed by Wilson in 1928. It is very popularly known as EOQ (Economic Order Quantity) model or 'Wilson's Lot Size formula'.

When dealing with stocked items, the two important decisions to be made are-how much to order and when to order. EOQ attempts to provide answer to former while the Reorder point (RoP) provides the answer to the latter.

The following assumptions are made in the standard Wilson lot size formula to obtain EOQ:

- Demand is continuous at a constant rate
- The process continues infinitely.
- No constraints are imposed on quantities ordered, storage capacity, budget etc.
- Replenishment is instantaneous (the entire order quantity is received all at one time as soon as the order is released).
- All costs are time-invariant.
- No shortages are allowed
- Quantity discounts are not available.

The inventory status under EOQ-RoP policy is continuously reviewed. Figure VI (a) shows the behaviour of such a simple system whereas Figure VI (b) shows the total system cost behaviour highlighting the conflicting trend of ordering and inventory carrying costs. EOQ aims at minimising total system cost.

Figure VI (a): Inventory Behaviour under Classical EOQ Model.

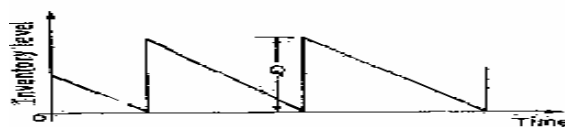
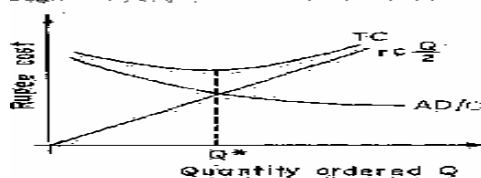

Figure VI (b): Total Cost Curve under EOQ Model.



Let us use the following notation in developing the classical EOQ model:

D = Demand rate; unit per year.

A = Ordering cost; Rs./order.

C = Unit cost, Rs. per unit of item.

r = Inventory carrying charge per year.

H = Annual cost of carrying inventory/unit item = r.c.

TC = Total annual cost of operating the system Rs./year (objective function).

Q = Order quantity, Number of units per lot (decision variable).

Since demand is at uniform rate average inventory is Q/2 throughout the year and the total number of orders are (D/Q) per year. Thus total annual cost of operating the systems consisting of carrying cost and ordering cost can be written as:

$$TC = A\left(\frac{D}{Q}\right) + \frac{H.Q}{2}$$

This gives $Q^* = EQO = \sqrt{\frac{2AD}{H}}$

Minimum cost = $TC^* = \sqrt{2AHD}$

Due to convex nature of total cost curve, it is obvious that Q* (EOQ) gives the global minimum total cost. It can also be seen that EOQ is obtained at the point of intersection of ordering cost and carrying cost in Figure VI (b).

Some interesting insight may be obtained using this classical system:

- i) If ordering cost is of high tendency, the optimal policy is to have high EOQ thus raising average inventory level.
- ii) If r or c are high leading to high value of H, the tendency will be to go for smaller lot sizes.

r may vary from 0.15-0.30 and will depend on the nature of item, A the ordering cost should be marginal ordering cost while H should be based on total purchased cost of the items.

Finite Replenishment Rates

We will now relax the assumption (d) of the classical EOQ model and permit finite replenishment rate (staggered deliveries). When the rate of procurement is P in units/year and the demand rate is D, in units/year, the build up of inventory is at a rate (P-D) due to simultaneous consumption. It is obvious that P > D for inventory to build up. Figure VII shows the inventory behaviour with finite supply rate. The stock builds

Figure VII: Inventory Behaviour under Finite Replenishment rate.

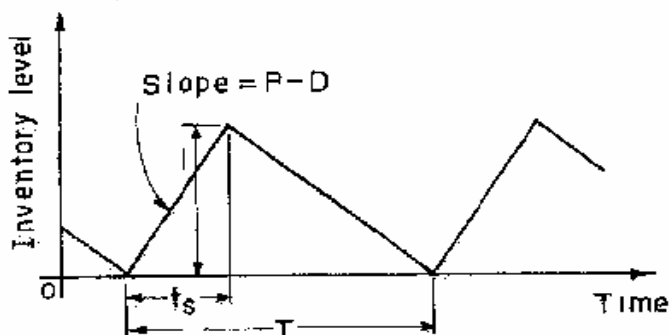

up to a maximum level I during supply period t_s , after which stock depletion takes place at rate D. It can be seen that

$$I = t_s(P-D); \quad t_s = Q/p$$

Thus $TC = A(D/Q) + H Q/2(1-D/P)$

For minimum TC we get $Q^* = \sqrt{\frac{2AD}{H(1-D/P)}}$

and $TC^* = \sqrt{2ADH(1-D/P)}$



Some interesting observations can be made about the behaviour of such systems. These are:

- i) Q^* under finite replenishment rates are higher than Q^* under classical EOQ model for the same values of other parameters.
- ii) Total system cost under optimal Q^* is lower than corresponding total system cost and EOQ model.
Thus staggering the supplies always reduces inventory level and total operating system cost provided other cost parameters remain the same.
- iii) As $P \rightarrow \infty$, Q^* and TC^* obtained are same as in standard Wilson's formula of instantaneous replenishment.
- iv) At $P = D$, $Q^* \rightarrow \infty$ $TC \rightarrow 0$. Thus if we can have a fully devoted reliable supplier, then placing a single supply order of large size but matching supply rate with the demand rate is the optimal decision. Under such a system, no stocks are built, no replenishments are made, no shortages are incurred. This would seem to be an ideal system towards zero-inventory provided we know our requirements for sure and we have a dependable source to supply us at the rate to match the requirement. This brings out the role of dependable source of supply as an important asset to materials management function.

Planned Backlogging

Let us now consider the effect of relaxing assumption (f) of classical Wilson's model by permitting backlogging (shortages or back ordering) at a unit shortage cost of S in Rs./unit short/year. In such a case negative inventory shows the backlogging position. The order quantity Q is partly used to clear the backlogging level B and $(Q-B)$ is the maximum stock level. Figure VIII shows the inventory behaviour under planned

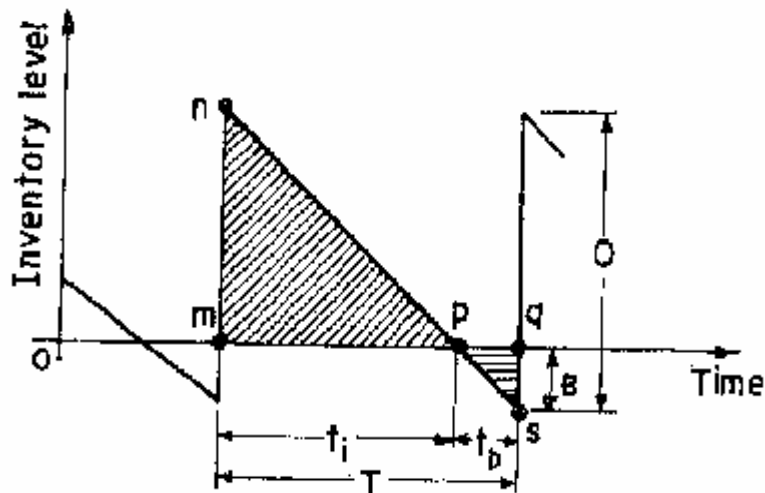

backlogging. Inventory is maintained for duration t_i and demands remain backlogged for duration t_b . Total cycle time of each replenishment cycle is

$$T = t_i + t_b$$

$$t_i = \frac{Q-B}{D}, t_b = B/D$$

It can be seen that , average inventory =

$$\frac{(Q-B)^2}{2Q} \text{ and average back order level} = \frac{B^2}{2Q}$$

TC = Total annual system cost

$$= A(D/Q) + H \frac{(Q-B)^2}{2Q} + S \cdot \frac{B^2}{2Q}$$

optimal values of Q and B can be obtained for minimum value of TC as follows:

$$Q^* = \sqrt{\frac{2AD}{H}} \sqrt{\frac{H+S}{S}}$$

$$B^* = \sqrt{\frac{2AD}{S}} \sqrt{\frac{H}{H+S}}$$

$$TC^* = \sqrt{2ADH} \sqrt{\frac{S}{H+S}}$$

Maximum Stock level = $Q^* - B^*$

$$= \sqrt{\frac{2AD}{H}} \sqrt{\frac{S}{H+S}}$$

Some useful observations could be made about the behaviour of inventory system with planned backlogging as follows:

- a) Total system cost is lower with planned backlogging than the corresponding total system cost under classical Wilson's lot size formula. Thus for a deterministic system with finite backlogging cost, it is economical to plan for backlogging. It can be seen that at $S \rightarrow \infty$, the model reverts to classical EOQ model.
- b) EOQ under backlogging is higher and maximum stock level is lower than the corresponding values under classical Wilson's lot size model.
- c) If $S = 0$ then $B^* = Q^* = \infty$. This means that with no charge for back orders one would keep piling up unfilled demand until the backlog gets infinitely large. Then one single order would be released to satisfy all accumulated demand. However, considering intangible cost of backordering such as loss of goodwill etc. it is debatable whether there are situations when the unit cost of shortages (S) is really zero.

Model with Quantity Discounts

Frequently, the vendors offer quantity discounts on bulk purchases to encourage users to place orders in large quantities. Quantity discounts may be all unit discounts or incremental quantity discounts. In all unit discounts entire order quantity is purchased at lower unit price if order size is higher than or equal to the stipulated conditions. In incremental case only quantity exceeding the threshold point is charged at lower unit cost. The immediate reaction may be to avail the discount and place bulk orders but if we see the total system cost, our decision may be otherwise. There may be a single or multiple quantity discounts. Figure IX shows total system costs under four discounts.

Figure IX: Total Cost Curves under Quantity Discounts

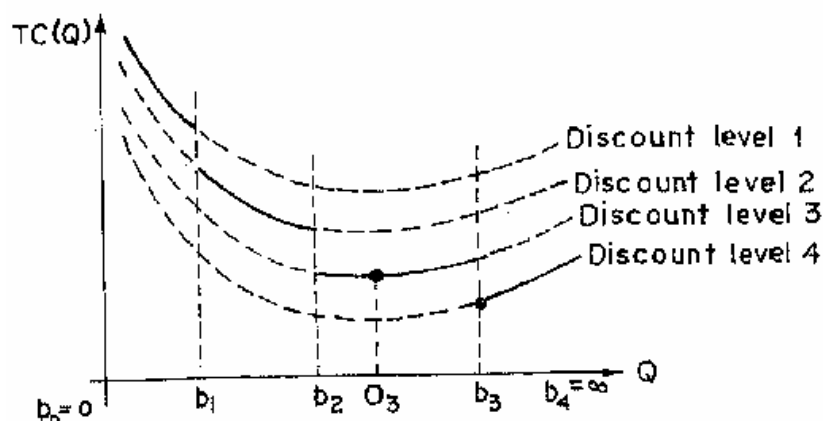

The broken lines show the total cost curves without price break whereas solid lines show the actual total cost if price break takes place. The larger the number of price breaks, the more difficult it becomes to analyse the situation as more alternatives are to be evaluated. The important point to be made in such situations is that individual tuation is to be analysed to judge which of the options is suitable to avail discount



and place bulk order to make it realisable, reject the offer and place small order at higher unit price or place order at the minimum possible quantity at which discount becomes valid. Any alternative is optimal if that minimises the total system cost. For example, it can be easily seen from Figure IX that for this case the minimum total system cost occurs at $Q^* = b3$ is the minimum quantity at which discount level 4 is applicable.

Sensitivity Analysis

It may not be operationally very convenient to stick to EOQ if it is an odd figure. Then one may like to know the repercussions on total system cost if one deviated either way from Q^* . This is done through sensitivity analysis. If Q_a is actual order quantity, $Q_a = b.Q^*$ where b is sensitivity parameter. If $b = 0.8$ then actual Q_a is 20% less than Q^* and if $b = 1.2$ then Q_a is 20% less of higher than Q^* . Obviously the TC will increase over TC^* in either case. If we substitute Q_a as bQ^* in total cost expressions in the classical EOQ model, we can easily get the following relationship.

$$\frac{TC_a}{TC^*} = \frac{1 + b^2}{2b} = p$$

where TC_a is actual cost with order size being Q_a . It can be seen that at $b = 1$, $p = 1$. If b is allowed to vary within 0.9 to 1.10 then p will be within 1.005 indicating that $\pm 10\%$ deviation in EOQ leads to less than half a per cent increase in TC. Thus TC is not very sensitive to EOQ and for operational convenience we should be able to vary EOQ within $\pm 10\%$ of Q^* without adversely affecting total system cost.

17.7 PROBABILISTIC INVENTORY MODELS

Impact of Demand and Lead Time Uncertainties

In the inventory models described in previous section we assumed that there was no uncertainty associated with the demand and replenishment-lead times. However, in reality there is always some uncertainty associated with the demand pattern and lead times. It can be shown that as the uncertainty (variability) of demand and lead times increases, extra stock in the form of safety stock (buffer stock) is required to account for these uncertainties. In the deterministic system, reorder point is very easy to determine as it is the demand during the lead time. For example, if the demand is uniform at a rate of 100 units/month and lead time is 3 months, then in the deterministic system the reorder point is 300 units. However, if there is variability of demand and times, an extra buffer stock will be added to the expected demand during the lead times, to obtain the reorder point. Furthermore, despite higher reorder point due to extra safety stock to provide cushion for system variability, there will still be a probability of stock out. Figure X shows the mechanics of occurrence of shortage in a probabilistic inventory system. If X_L is the average demand during the lead time and

Figure X: Occurrence of stockout under probabilistic inventory situation.

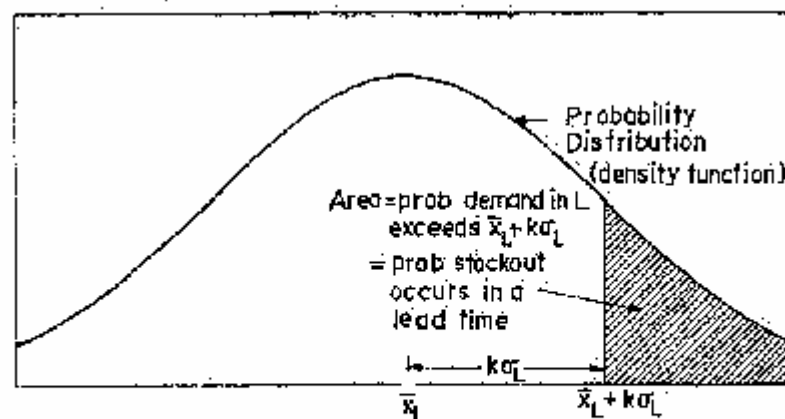

Total Demand in Lead Time

\bar{x}_L - forecast demand over replenishment lead time

σ_L - standard deviation errors at a forecast over a lead time

Figure σ_L is the standard deviation of lead time demand and if reorder point is set of $X_L + K \sigma_L$ for normally distributed demand, then the shaded area of Figure X gives the probability of stockout during the lead time. This value can be obtained from standard normal tables for various values of K .



Determination of Reorder Point

As stated earlier, the Reorder Point (R) in the probabilistic lot size inventory system is given by:

$$\begin{aligned} R &= \text{Expected demand during lead time} + \text{Buffer (safety stock)} \\ &= X_L + K \cdot \sigma L \end{aligned}$$

For obtaining X_L and σL from the distribution of demand and lead times a lead time demand distribution (LT.DD) such as shown in Figure X can be obtained. The following expressions characterise the LTDD:

$$\begin{aligned} X_L &= D \cdot L \\ \sigma^2 L &= \sigma^2 L + D^2 \sigma^2 l \end{aligned}$$

where D = Expected demand rate
 σd = Standard deviation of demand rate
 L = Expected lead time
 σL = Standard deviation of lead times

Therefore,

$$R = D \cdot L + K \sqrt{\sigma a \cdot L + D^2 \sigma \cdot l^2}$$

This expression quantitatively incorporates the effect of demand and lead time variability on R and buffer stock. It can be seen that as a , l increase, signifying higher demand and lead time variability, the Reorder point and buffer stock increases. If lead time is constant at L , then $\sigma l = 0$ and $R = D \cdot L + K \cdot \sigma d \sqrt{L}$. Similarly if the demand is constant, $a d = 0$, then

$$R = D \cdot L + K \cdot \sigma l \cdot D$$

If both demand and lead times are constant, $\sigma d = 0$, $\sigma l = 0$, then

$$\begin{aligned} R &= D \cdot L \quad (\text{Demand during lead time}) \\ \text{Buffer stock} &= 0 \end{aligned}$$

Safety Stock and Service Levels

In the determination of safety stock, the factor K obtainable from normal distribution tables for normally distributed lead time demand, depends upon the risk of shortage we are prepared to accept. Higher value of K means less risk of shortage (or high service level) and vice-versa. For example if $K = 1$, then risk of shortage is 15.87 % or service level is (100-15.87 = 84.13%). At $K = 2$, the risk of shortage is 2.28% and at $K = 3$, the risk is 0.13 % only. Obviously, at $K = 0$, buffer stock is zero but risk of shortage is 50% . Thus we can choose K (hence buffer stock) for a prescribed risk of shortage during a lead time.

17.8 INVENTORY CONTROL OF SLOW MOVING ITEMS

Nature of Slow Moving Items

As stated earlier, slow moving materials are those which are not regularly demanded and their movement off the shelf is very occasional, say once in six months or so. Examples of slow moving materials can be -- spare parts and some special purpose materials for projects required only for a certain kind of project activity. Inventory models valid for fast moving models are not applicable for slow moving items due to lack of regular demand pattern. Generally slow moving items are quite expensive and therefore one has to first decide whether to keep them all in stock and if to keep them in stock then in what quantity further difficulty of slow moving parts is that initial over-buying decision could take years to remedy the situation due to rarely occurring demands.

Some Inventory Policies for Slow Moving Spares

We shall illustrate our approach to manage the inventory of slow moving items with spares inventory problem as a substantial percentage of spares come under the slow moving categories. Some of the strategies that could be possibly adopted for efficient inventory management of slow moving spares are as follows:

a) If spares are required only at pre-specified time such as at the time of major scheduled maintenance for replacement, then it is better not to stock them but to place procurement order sufficiently well in advance, keeping lead times in mind, so that these arrive just in time when these are needed.



b) If the part gives adequate warning of impending break down, then also the best policy is to place an order the moment we get the warning. Adequate warning refers to the case when the lead time required is less than the warning time. This shows that major improvements in slow moving inventory are possible by cutting down the lead times.

c) For inadequate warning spares we must keep the stock. Generally maximum stock level will be 1 or 2 and the (S-1, S) or one-for-one ordering policy is very useful. This means placing an order for one spare when one is consumed.

17.9 RECENT DEVELOPMENTS IN INVENTORY MANAGEMENT

Multi-echelon Inventory Systems

The inventory models described in the preceding sections pertained to situations where the stock is located at a single place. In practice the stock may be distributed over several locations. For example in a multi-project organisation, there may be a central store and a number of field stores or project stores. Such types of inventory systems are called 'Multi-echelons inventory Systems'. Since the inventory in all the locations belong to the same system, it is better to look at the inventory management for the system as a whole rather than treating each storage location independently. Recently a lot of attention has been given by the researchers to the analysis of such multi-echelon inventory systems. Important decisions concerning the design and operation of such systems are the number of echelons, number of storage points at each echelon (level), location of central store, optimal inventory policy to be followed by each storage location, stock redistribution policies etc. For very expensive slow moving item such as complex assemblies it may be desirable to locate the inventory at the central store rather than the project (field) store provided the item is standardised and is usable at each locations. Detailed mathematical analysis of multi-echelon inventory systems tends to be rather complex and is beyond the scope of this unit.

Materials Requirement Planning

Materials Requirement Planning (MRP) is an important concept and is increasingly becoming popular because of increasing role of computer based planning and control systems. MRP is useful for situations having products with inverted tree like structure so that the demand for parts and sub-assemblies is dependent upon the master production schedule of the end-product. The MRP concept provided a very basic and different way of looking at the management of production inventories. MRP inputs are master production schedule; bill of materials and inventory status. MRP software package computes the parts requirement, and prepares production and procurement schedules. This indicates the increasing role of computers in inventory planning.

17.10 CONCLUDING REMARKS

Inventory management is an extremely important problem area in the management of materials. It is quite susceptible to control and a very large amount of scientific models are available in the literature to enable us to choose an optimal inventory policy. Buying the optimal quantity can result only from a sound inventory control system which is achieved by judicious reconciliation of conflicting costs and departmental objectives. However, inventory is only an indicator of performance of materials management function and to cut down inventories we use not only scientific inventory management principles and models but also take long-term measures to reduce inventories through strategies such as variety reduction and standardisation, source development and vendor rating, lead-time reduction through improvements in the systems and procedures of procurement. It is obvious that scientific inventory management has to be practised selectively rather than indiscriminately to make it cost-effective. It is also important to have informational inputs like demand forecast, lead time estimate and other cost estimates to be realistic to make effective use of inventory models.



17.11 SUMMARY

This unit has attempted to highlight the role of inventory management in the successful operation of any production or service system. Functions of inventory and various inventory related costs parameters have been identified. Various operating inventory policies have been described. ABC/VED/FSN analysis concepts have been outlined to enable selective control on inventories and the role of exchange curve to quickly detect the irrationality of existing procurement practice has been highlighted. Some deterministic models to determine EOQ are presented and sensitivity of classical EOQ model is analysed. Impact of demand/lead time variability on reorder point and buffer stock has been explained. Problems of slow moving items inventory control has been identified and some guidelines have been given. Recent developments in inventory management have also been given.

17.12 KEY WORDS

ABC Analysis: Arranging items according to annual usage value in three categories A, B and C to identify significant few and insignificant many.

Annual Usage Value: Annual demand multiplied by unit price.

Backlogging: Process of accumulating unsatisfied demand till fresh replenishment of stock is made available.

Buffer Stock: Extra safety stock needed to absorb variation in demand and supply to provide cushion.

Carrying Cost: Cost associated with holding one unit in inventory for one time period (year).

Dead Stock: Material not demanded for a very long period due to obsolescence etc.

Exchange Curve: A curve indicating optimal trade off between total inventory and total number of orders (also called optimal policy curve.)

EOQ: Economic Order Quantity; the quantity for procurement which will result in minimum total system cost associated with carrying, ordering and backlogging.

FSN Analysis: Classification of items according to frequency of usage in Fast, Slow and Non-moving groups.

Inventory: Usable but idle resource having economic value.

Inventory Turnover Ratio: Annual demand divided by average inventory.

Lead Time: Time that elapses between placement of an order and actual receipt of materials.

MRP: Materials Requirement Planning; a system of order scheduling for dependent demand situation.

Multi-echelon Inventory System: A system of inventory control where the stock is located at different levels (echelons) at different locations.

Optional Replenishment Policy: An operating policy based on maximum and minimum stock levels with periodic review, popularly known as (s,S) policy.

Ordering Cost: Cost associated with placing a purchase order expressed as Rs./order.

Quantity Discount: A sales promotion strategy by vendor in which bulk purchases can be made at lower unit prices.

ROP: Reorder point; the stock level when the action for replenishment of stock be initiated by placing an order.

Service level: Percentage of times an item is available in stock when demanded.

Slow Moving Item: Items which are very occasionally demanded.

VED Analysis: Process of grouping items into Vital, Essential and Desirable categories depending upon the criticality of the items.



17.13 SELF- ASSESSMENT EXERCISES

- 1 An organisation is spending Rs. 20 crores annually in procuring a total of 50,000 different items. Using simple empirical decision rule to group items into A, B and C category, determine the cut off values of annual usage that will decide whether the item should be A, B or C class item.
- 2 Write true or false against the following statements:
 - i) Perishable items should have higher value of inventory carrying charge than imperishables.
 - ii). EOQ is smaller if backlogging is permitted under deterministic demand.
 - iii) $\pm 10\%$ variation around EOQ is not very serious.
 - iv) Finite replenishment rates enable more economical operation of an inventory system.
 - v) Buffer stocks have no relationship with the amount of demand/lead time uncertainties.
- 3 In an inventory system the cost of placing an order is Rs. 100/order. The. annual demand is 5000 units and the inventory carrying charge is 20% of the value per year. The item costs Rs. 75 each. Find EOQ and total system cost if shortages are not to be allowed.
- 4 If shortages are permitted and allowed to remain backlogged at a cost of Rs. 60 per unit short/year, determine the EOQ , maximum stock level, maximum backlog level and the total system cost under optimal condition for the data pertaining to problem number 3 above.
- 5 In an inventory system using classical EOQ model of Wilson, determine the Lange of variation of EOQ if 1% increase in cost over the minimum total cost is permissible. EOQ has been determined to be 400 units.
- 6 n item is demanded at the rate of 2000 units per year at a uniform rate. Ordering cost is Rs. 350 order. Inventory carrying cost is 24% of the unit price per year. The supplier has offered a unit price of Rs. 100/item but he is willing to reduce it to Rs. 95/item if a purchase order of 1000 units or more is placed. Should you accept this offer?
- 7 An item is demanded at an average rate of 100 units/week with a standard deviation of 10 units. The lead time is normally distributed with a mean of 10 weeks and standard deviation of 2 weeks. If the lead time demand distribution is normal, find the reorder point and buffer stock if 2.28% risk of shortage can be accepted during a lead time.
- 8 "Inventory management for slow moving expensive items should focus more on lead time reduction than anything else". Critically examine the statement.
- 9 Who should be responsible for inventory control? Discuss this statement from a departmental as well as top management points of view.
- 10 Consider the following situation:

An inventory system has four items to be procured from different sources. Procurement action is based on each item to be considered individually and independently. The following data have been obtained for demand and unit prices for each item:

Item, i	Demand D_i	Unit price V_i (Rs./unit)
1	7500	200
2	4000	90
3	500	500
4	100	80

The inventory control manager argues vehemently that there is no way to estimate ordering and carrying costs but he is prepared to accept that ordering cost to fraction of carrying charge is constant for each item. Currently he is following an' ordering



policy of using a 4-month supply of each item. He is under pressure to cut down inventory by 25% and is therefore about to adopt a policy of 3-month supply. Use exchange curve to show that he has better options available to him. What should he do?

17.14 FURTHER READINGS

Dobler, D.W., Lee, L., Jr. and Burt, D.N., 1984. *Purchasing and Materials Management: Text and Cases*, McGraw, Hill, Inc.: New York.

Gopalakrishan, P. and Sundaresan, M., 1979. *Materials Management: An Integrated Approach*, Prentice-Hall of India (P) Ltd.: New Delhi.

Hax, A.C., and Candea, D., 1984. *Production and Inventory Management*, Prentice-Hall Inc.: Englewood-Cliffs.

Lewis, C.D., 1970. *Scientific Inventory Control*, Butterworth: London.

Peterson, R. and Silver, E.A., 1981. *Decision Systems for Inventory Management and Production Planning*, John Wiley & Sons: New York.

Plossl, G.W. and Wight O.W., 1979. *Production and Inventory Control, Principles and Techniques*, Prentice-Hall of India Ltd.: New Delhi.